



# Aluminum Gazebo

## Installation Instructions

1-800-966-9261

Thank you for purchasing our Aluminum Gazebo Kit! We have taken great time and care in designing a high-quality product that will last for years with little set-up and maintenance. Our gazebos come with pre-fabricated modular walls and pre-cut components to minimize the time necessary for assembly and installation. Please follow these instructions in the assembly and completion of your gazebo to ensure a finished project that will look beautiful and provide years of enjoyment.

**NOTE:** Dealer or homeowner is responsible for providing a proper deck, foundation, or slab to which the gazebo may be secured. Your gazebo is designed to be a free-standing structure secured only to a deck, foundation, or slab. Gazebo Junction, Inc. accepts no responsibility for damage caused to the gazebo or other property by faulty foundation or installation.

**CAUTION:** Do not attempt to assemble and install your gazebo in wind conditions of more than 12 mph. In windy conditions the modules, and roof panels are difficult to handle and could result in damage. Also, it becomes difficult to achieve and maintain the proper verticality of the corner posts during installation.

**NOTE:** The Solid Roof does not include drip edge, roof felt, or shingles necessary for a shingled appearance. You can purchase these materials of your choosing at your local building products supplier in order to get the proper color and texture you desire. Material quantities can be found in section "F" as part of the solid roof installation instructions.

### Assembly Overview

**Estimated Time Requirements:** The following time estimates are based on 2 people (*at least 2 people are required for assembly; more may be required for installation of the solid roof, especially on large-size models*).

|                          |  |
|--------------------------|--|
| Wall System Assembly:    | 2-4 hours depending on size                |
| Solid Roof Installation: | 4-6 hours depending on model type and size |
| Shingling (solid roof):  | 4-8 hours depending on size                |

#### **Installation Outline:**

- A. Recommended Tool List.
- B. Deck or slab preparation.
- C. Base Channel Installation.
- D. Wall Module Installation.
- E. Top Cap Installation.
- F. Solid Roof Installation.
- G. Door Installation.

#### **Dimensions:**

Please see Appendix A for model drawings and approximate dimensions.



# Aluminum Gazebo

## Installation Instructions

1-800-966-9261

### A. Recommended Tool List

- Tape Measure
- Phillips Screwdriver
- Power Drill/Driver
- 1/8" Drill Bit
- 5/16" Drill Bit
- 2 Ladders
- Hacksaw
- 7/16" Socket
- 1/4" Hex Driver or Bit
- 7/16" Hex Driver or Bit
- Level
- Square Drive Bit (included)
- Caulking Gun

#### Additional Tools Required for Solid Roof:

- Rubber Mallet
- Tin Snips

### B. Deck or Slab Preparation

Prior to installing the base channel, check the deck or slab to make sure it is level, structurally sound, and of appropriate size to fit the gazebo. Appendix A shows outside dimensions of the various gazebo models. For pitched/sloped decks or slabs, prepare a flat and level base perimeter at least 2 3/4" wide to which the base channel can be attached.

### C. Base Channel Installation

Connect the base channel pieces (diagram **C-1**) to each other and layout in the form of an octagon using eight (8) corner connectors (diagram **C-2**). The short pieces of base channel are for the door module. Locate these on each corner of the wall where the door will be placed. If not pre-cut, use a hacksaw to cut the aluminum door threshold to 36" and locate it between the short pieces of base channel.

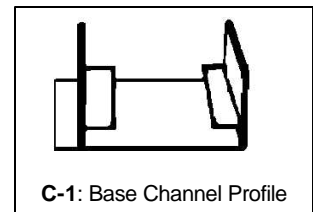

C-1: Base Channel Profile

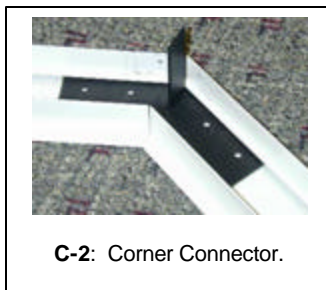

C-2: Corner Connector.

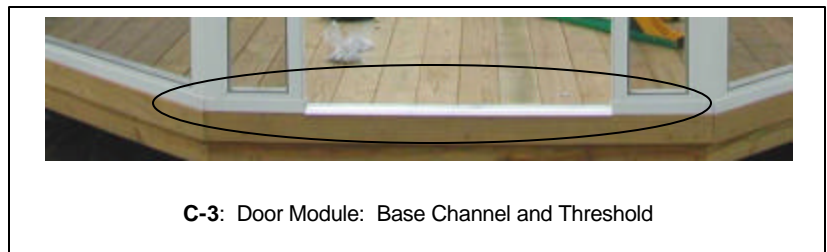

C-3: Door Module: Base Channel and Threshold

Measure across the sides of the layout to the outside edge to ensure equal distances. When the base channel is properly located, trace the inside dimensions of the base with a pencil. **[For glass gazebos: remove the base channel and run a solid bead of clear silicone about 3/4" from the trace lines all around the perimeter so that the base channel will have a water-tight seal.]** Secure the lengths of base channel and corner connectors with lags (deck) or Tapcon screws or anchors (slab) and washers, about 1 every two feet, checking to make sure the base channel is located properly on the trace lines. (There are 8 holes per corner connector, but you only need to use 4 fasteners. Also center and secure the aluminum door threshold to the deck or slab with the screws provided.



# Aluminum Gazebo

## Installation Instructions

1-800-966-9261

### D. Wall Module Installation

Wall modules come pre-assembled and pre-screened to simplify installation. **CAUTION:** Take care while unpacking and assembling the wall modules to avoid putting holes or rips in the fiberglass screen. However, should one or more modules need re-screening, the rubber screen spline is easily removed and re-used. Replacement screens and a spline roller can be purchased at your local building products store,

**Electrical Considerations:** The roof system supports a ceiling light or ceiling fan from the hub (octagon) or center ridge beam (oval). If you want electrical service to the gazebo, you should plan for this at this time. You can use the space between the wall modules and corner post as a conduit to run wire up the walls of the gazebo and then up a ridge beam of the roof. Consult an electrical contractor for proper installation and code compliance.

Starting with the section to the left of the door module (viewed from outside), place a corner post at one of the corners by fitting it into the base channel. Holding it vertical, secure it to the base channel with 2 self-tapping screws ( $\frac{3}{4}$ " square-drive) from the outside, locating the screws within  $\frac{3}{4}$ " from the corner point (diagram D-1). Attach the corner post to the vertical leg of the corner connector with 2 more self-tapping screws. Insert a wall module into the base channel and corner post (screen towards outside). The module should fit into the corner post about 1".

Secure the module to the corner post using ( $\frac{3}{4}$ " square-drive) self-tapping screws as shown in diagram D-2, both inside and outside. **Do not install screws at the top yet, as the top cap must fit over the assembly later and the screws will be in the way.** Also secure the module at the bottom to the base channel (3-4 screws per side), both inside and outside.

Moving clockwise around the gazebo, insert each successive wall module and secure as above. The door module will be the last module installed. Secure the door module as the other wall modules, making sure the frame sits flush to the door threshold.

### E. Top Cap Installation

After all wall modules have been installed and secured, position the top cap pieces (without securing yet) and make any adjustments so that the mitered corners meet with minimal gaps. You may need to push or pull on certain walls to draw them in our out.

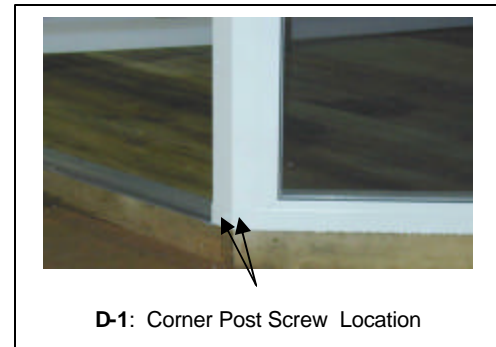

D-1: Corner Post Screw Location

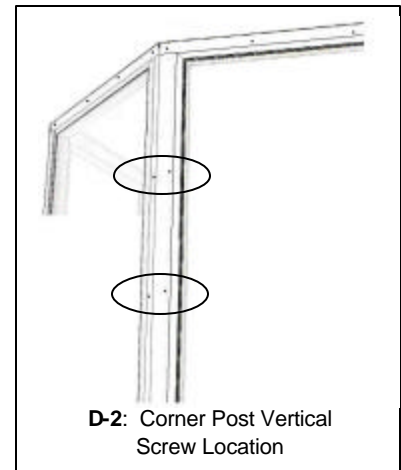

D-2: Corner Post Vertical Screw Location



# Aluminum Gazebo

## Installation Instructions

1-800-966-9261

Check wall modules and corner posts to ensure they stay vertical. Secure each top cap piece with four (4) 3/4" self-tappers, both inside and outside, similar to the screw locations on the base channel. **Be sure the top cap has been fully secured before moving to the roof installation.**

### F. Solid Roof Installation

**Caution!** Wear gloves when handling roof panels to avoid cuts.

The solid roof system of the Styleline gazebo is framed using a "hub and spoke" assembly (diagram F-1).

With one person on the inside of the gazebo on a ladder holding the hub, the ridge beams should be passed over the gazebo walls, one at a time, for assembly to the hub. Insert each ridge beam into a hub assembly slot (with fan beam at bottom of hub) and secure with a cotter pin. Secure each ridge beam to the outside edge of the top cap by screwing through the connector plate into the top cap (diagram F-3).

**Electrical Considerations:** Prior to installing the roof system, you should determine if electrical service for a light or ceiling fan is desired. If so, complete the wiring plan and determine any additional access holes that are necessary in the hub. Wire runs should be completed before roof panels are installed. The ridge beams may be used as conduit by keeping the wire near the inside top of the ridge beam. The hub assembly has an aluminum cross-piece to secure a light/fan base. The oval hub assembly has a removable cover in the center for concealing the wire and securing a light/fan base. Consult an electrical contractor for proper installation and code compliance.

**\*Oval model only:** The oval model comes with two I-beams which run across the width of the gazebo on top of the wall system and support the two center posts. Set the two I-beams on top of the wall system and center each beam 23" from the center of the wall (diagram F-2). The centers of the beams should be 46" apart. Secure each end of each beam to the wall system with two (2) 1" self-tapping screws.

Locate the center posts of the hub assembly on the top of the I-beams. Center the U-Clips on the I-beam where the posts will attach and secure each clip with two (2) 3/4" self-tappers. Secure each center post to the U-clip with one (1) 3/4" self-tapper on each side. Secure the ridge cover to the variable pitch ridge beam with 3/4" self-tappers.

To install the roof panels, place one ladder on the outside and one on the inside of the gazebo. From the outside, lift the connected roof panels in place and insert into the ridge beam until the point reaches the hub.

Prepare roof panels for installation: Connect the left and right sections of each section as illustrated in **Fig. 3.1**. The plywood spline is pre-applied to one half of the roof section. Before connecting the two sections apply an approximately 3/8" thick X 1/2" wide bead of polystyrene adhesive in the opposite panel and connect the two panels. (Be sure to use the polystyrene in the one quart tube.

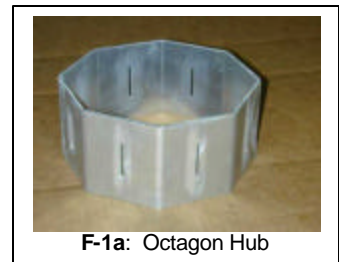

F-1a: Octagon Hub



F-1b: Oval Hub

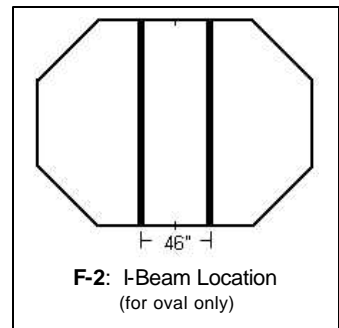

F-2: I-Beam Location  
(for oval only)

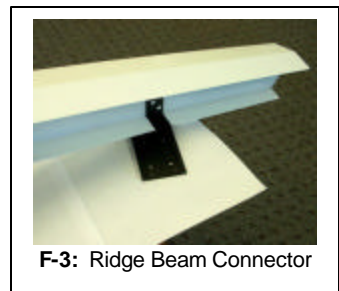

F-3: Ridge Beam Connector

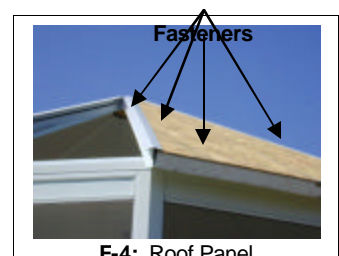

F-4: Roof Panel



# Aluminum Gazebo

## Installation Instructions

1-800-966-9261

Other sealants may destroy foam in roof panels.) Repeat this operation with all eight sections.

Before lifting the roof sections into place, you will need to install two wood screws as shown in **Fig. 3.2** to hold panels together as they are being lifted into place.

Finishing inside of roof System: On the inside of the roof, the seam in the center of each roof section will be covered by an extruded roof quad strip as shown in **Fig. 3.3** Measure and cut the quad strip. Apply an approximately 3/8" wide X3/8" deep bead of **Bondaflex adhesive** directly to the seam between the two roof panels in each section. Lay the quad strip on the floor and apply two beads of Bondaflex sealant as shown on each side. Let the sealant set for fifteen (15) minutes before installing over the seam.

Lift and place the left half part way up the roof, snap the two halves together and slide the left half the rest of the way into place.

If necessary, place a "scrap" piece of fascia over the end of the panel and, using a rubber mallet, carefully hammer the panel at the bottom corners to get it firmly in place at the top.

### Roof Installation continued:

Use 5" lag bolts, about 1 per foot, to secure the roof panel to the wall system by screwing them in vertically on the line marked on the top (approximately 10 1/2" up from the bottom of the panel). **For best results, as the lag starts to come through the under side of the roof panel, spot check to make sure it will hit the top cap without missing.** Continue installing the roof panels in the same way, working your way around each section. Use low-profile screws to secure the ridge beams to each panel.

When all roof panels have been installed, install the exterior fascia (diagram **F-5**) using 3/4" self-tappers, both top and bottom. The fascia should cover the bottom of the ridge beam and fit underneath the top of the ridge beam. Use a tin snips to trim any excess material. Cover corners with caps provided and 3/4" self-tappers.

Inside the gazebo, install the interior screw covers (diagram **F-6**) by snapping them onto the leg of the top cap. Use a tin snips to trim any excess material. Secure upper leg to the roof panel with 3/4" self-tappers.

Install the interior hub cover(s) in the ceiling with a 3/4" self-tapper. Use white silicone to seal any remaining gaps around the covers.

Complete the custom-look of your gazebo with drip-edge, roof felt, and shingles of your choosing (not included). Low-profile shingle screws have been included to secure the shingles to the aluminum roof. Please visit your local building products supplier in order to get the proper color and texture of shingles you desire. Below are the estimated materials required to shingle your aluminum gazebo.



F-5: Exterior Fascia



F-6: Interior Screw Cover



F-7: Shingling





# Aluminum Gazebo Installation Instructions

1-800-966-9261

## GAZEBO ROOF SECTIONS

APPLY APPROX. 1/2" WIDE X 3/8" THICK BEAD OF POLYSTYRENE ADHESIVE IN THE OPPOSITE PANEL AND CONNECT THE TWO PANELS.

(BE SURE YOU ARE USING POLYSTYRENE ADHESIVE IN THE ONE QUART TUBE. OTHER SEALANT'S MAY DESTROY FOAM IN ROOF PANEL.)

PLYWOOD SPLINE IS PRE-APPLIED TO ONE HALF OF EACH ROOF SECTION

APPLY APPROX. 3/8" X 3/8" DEEP BEAD OF BONDFLEX ADHESIVE DIRECTLY TO SEAM IN PANEL (METAL SIDE).

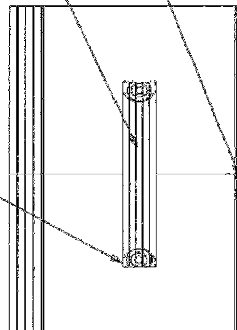

FIG. 3.1

INSTALL TWO WOOD SCREWS TO HOLD PANELS TOGETHER AS THEY ARE BEING LIFTED INTO PLACE

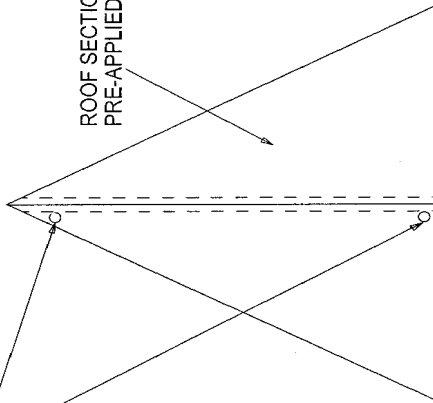

FIG. 3.2

LAY QUAD STRIP ON FLOOR AND APPLY TWO BEADS OF BONDFLEX SEALANT. LET SET FOR 15 MINUTES BEFORE INSTALLING OVER SEAM.



FIG. 3.3



# Aluminum Gazebo

## Installation Instructions

1-800-966-9261

|                | <b>Roof Shingles</b><br>(Sq. Feet) | <b>Ridge Cap Shingles</b><br>(Linear Feet) | (Optional)<br><b>Drip Edge</b><br>(Linear Feet) |
|----------------|------------------------------------|--|---|
| <b>Octagon</b> |                                    |  |   |
| 8'             | 100                                | 60   | 35  |
| 10'            | 150                                | 70   | 40  |
| 12'            | 200                                | 80   | 50  |
| 14'            | 270                                | 90   | 55  |
| 16'            | 360                                | 100  | 60  |
| <b>Oval</b>    |                                    |  |   |
| 8' x 12'       | 150                                | 65   | 40  |
| 10' x 14'      | 220                                | 75   | 50  |
| 12' x 16'      | 270                                | 85   | 55  |
| 14' x 18'      | 360                                | 95   | 65  |
| 16' x 20'      | 450                                | 105  | 70  |

### G. Door Installation

Follow the instructions included with the door and door hardware to mount and finish the door. Use the replacement nylon closure bracket (diagram **G-1**) instead of the one that comes with the door hardware kit to mount the hydraulic closure (diagram **G-2**) to the door frame.

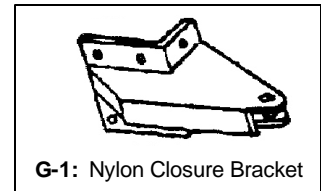

**G-1:** Nylon Closure Bracket

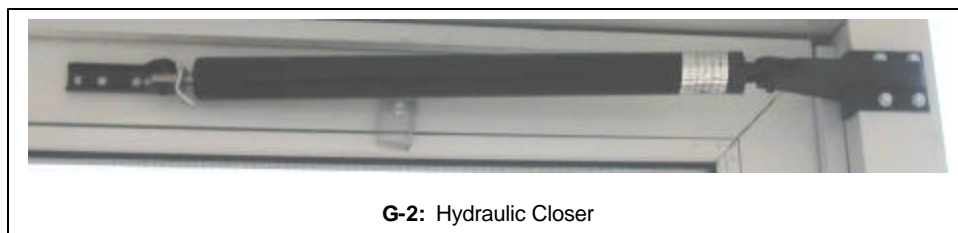

**G-2:** Hydraulic Closer